



D 1142, M 1268, M 1277 TATRA







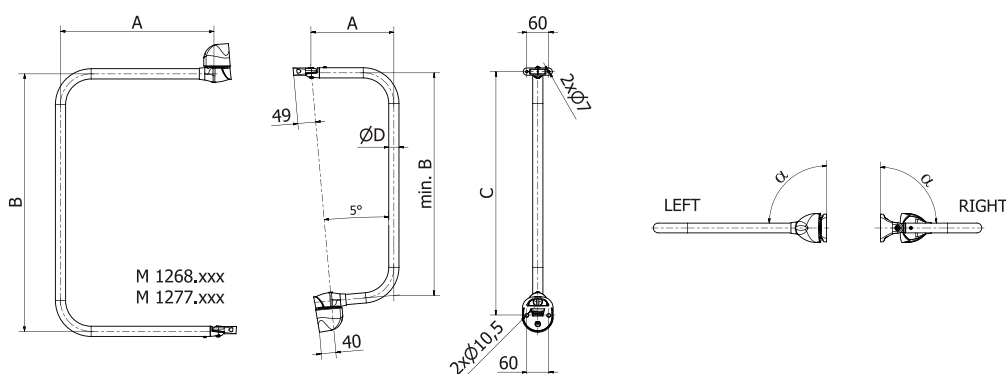







FE 

Číslo Nr.	Typ Type	A (mm)	B (mm)	C (mm)	D (mm)	(°)	(Kg)	Popis Description
2599	D 1142.31P	222	678	737	28	90	1,6	 
2598	D 1142.300	222	678	737	28	90	1,6	 
2569	M 1268.100	420	705	738	28	90	2,25	 
2588	M 1268.200	420	705	738	28	90	2,5	  
---	M 1277.100	420	900	933	28	90	2,8	 



D 128x, D 129x BUS

FE  + ABS

Číslo Nr.	Typ Type	A (mm)	B (mm)	C (mm)	D (mm)	(°)	(Kg)	Popis Description
2322	D 1286.20 L	126	280	---	20	80	1,25	  
2323	D 1288.20 P	520	400	---	20	10	2,65	  
---	D 1288.23 P	520	400	---	20	10	2,65	  
2312	D 1290.20 L	126	280	---	20	32	1,25	  
2313	D 1290.20 P	126	280	---	20	32	1,25	  
---	D 1294.20 L	126	280	---	20	122	1,25	